

GA6-3

GA6-3/032F-38 10Z GA6-3/250F-38 10Z
 GA6-3/032F-38 15Z GA6-3/250F-38 15Z

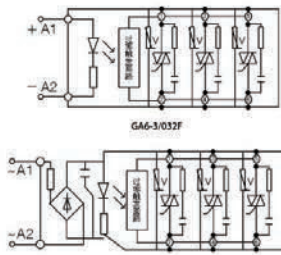

典型内部电路图

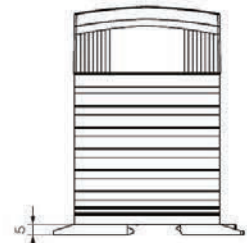
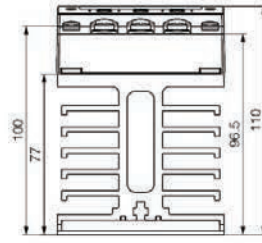
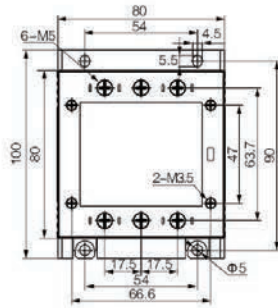
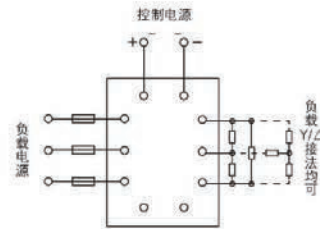

应用电路接线图

GA6-3/032F-38 20Z GA6-3/250F-38 20Z
 GA6-3/032F-38 25Z GA6-3/250F-38 25Z
 GA6-3/032F-38 30Z GA6-3/250F-38 30Z

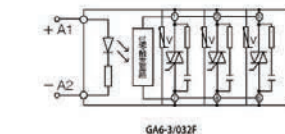
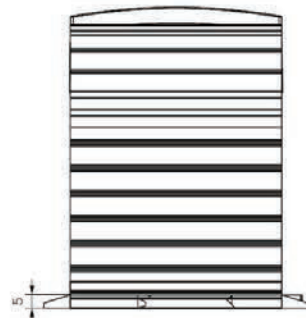
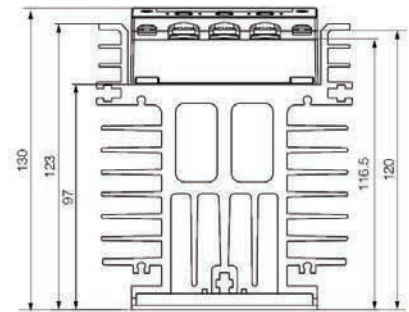
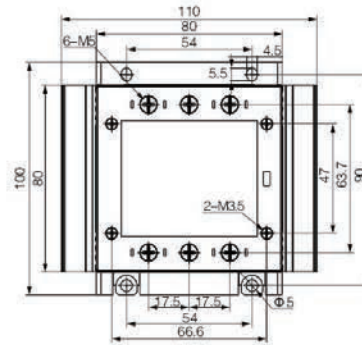

GA6-3/032F

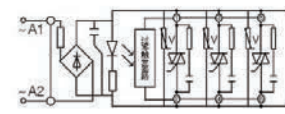

GA6-3/250F

典型内部电路图

GA6-3

GA6-3/032F-38 40Z
GA6-3/250F-38 40Z

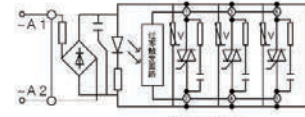
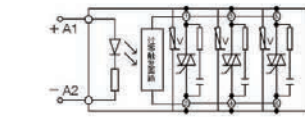
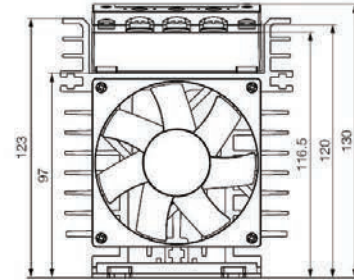
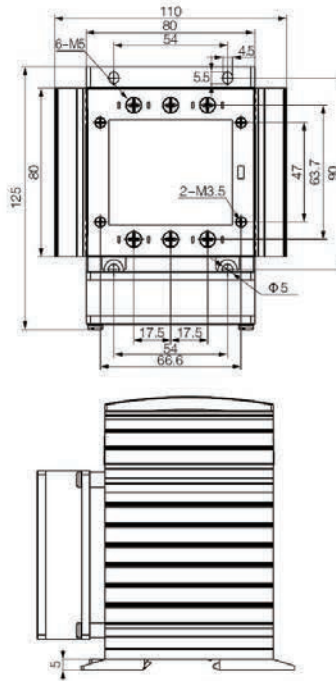

典型内部电路图

GA6-3/032F-60 60Z GA6-3/250F-60 60Z
GA6-3/032F-60 80Z GA6-3/250F-60 80Z

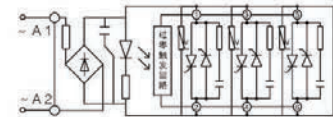
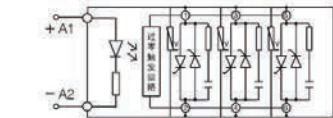
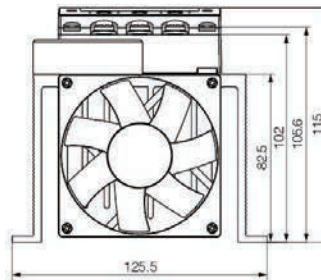
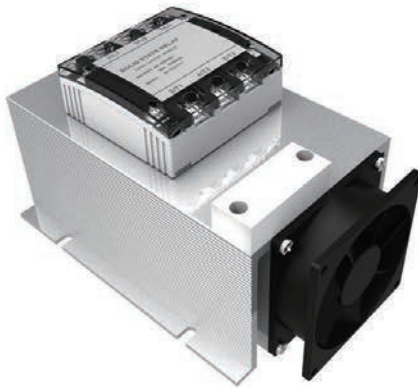

GA6-3/250F

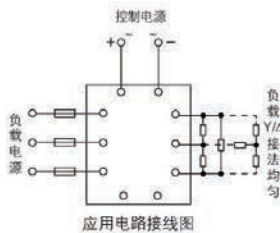
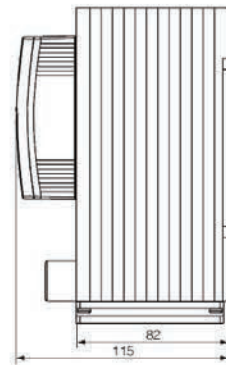
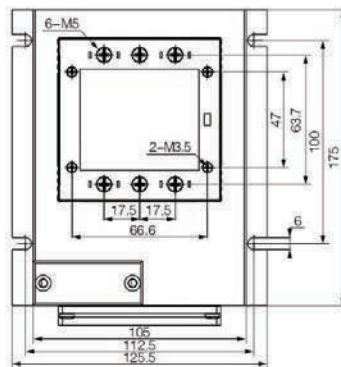

应用电路接线图